

MaxxECU

Anmärknings:

Kabelskärmar får endast jordas via ECU.
BLÅ TEXT är kabelmärkning.

Inkoppling av digital ingång

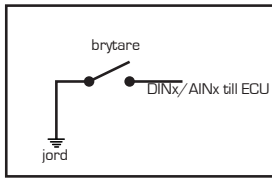

Sensor GND får **ALDRIG** kopplas mot chassie jord!

Alternativ för anslutning av vev/kamaxelgivare

Opto/hallgivare (digital)

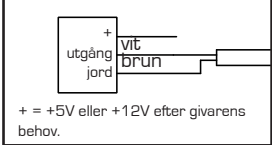

VR-givare (analog)

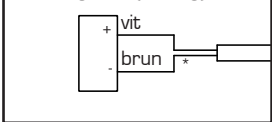

LSU kontaktdon sett från kabelsidan

WBO2 1

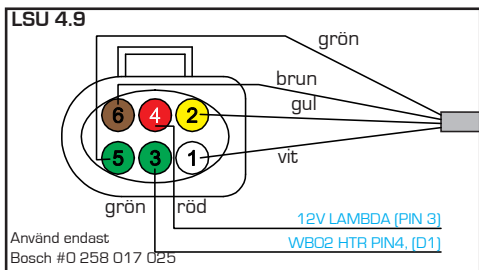
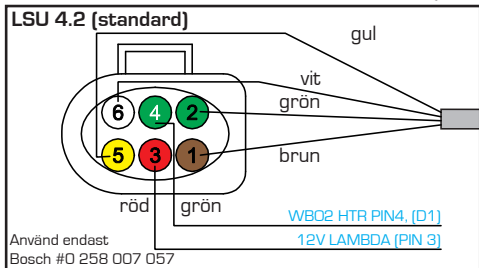

Warning! MTune inställning för korrekt LSU sond MÅSTE väljas innan inkoppling sker.

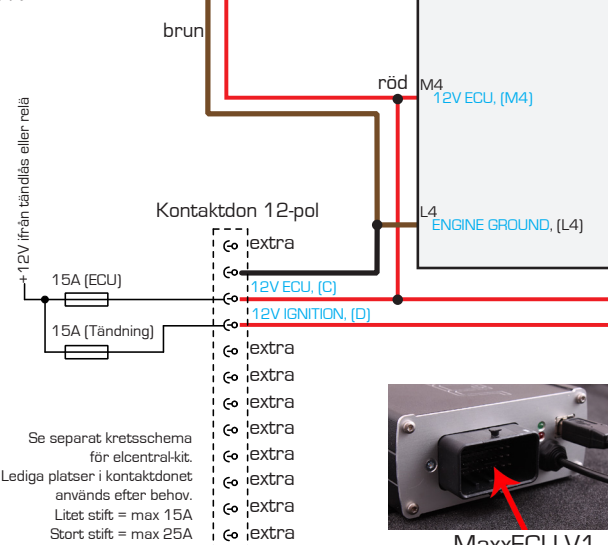
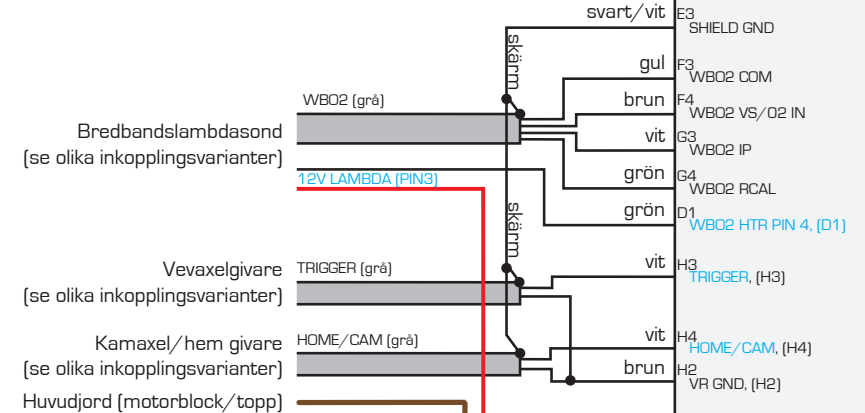
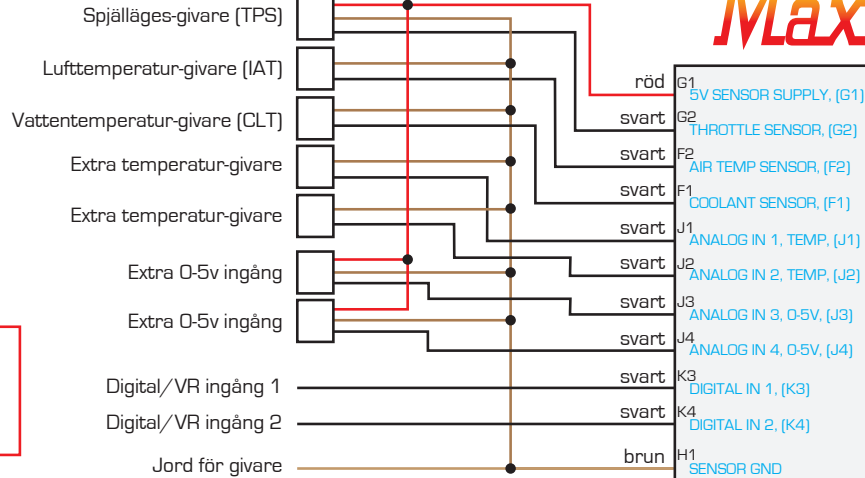

Se separat kretsschema för elcentral-kit.
Lediga platser i kontaktdonet används efter behov.
Litet stift = max 15A
Stort stift = max 25A

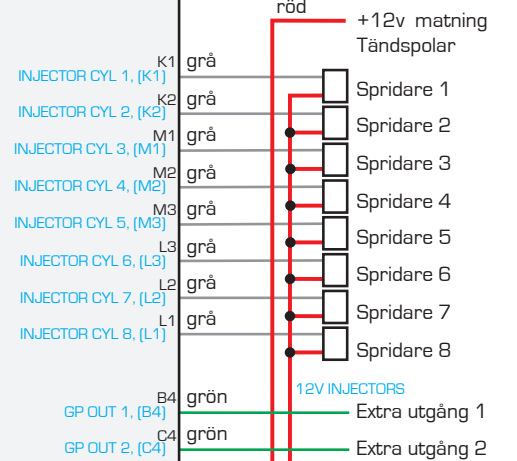
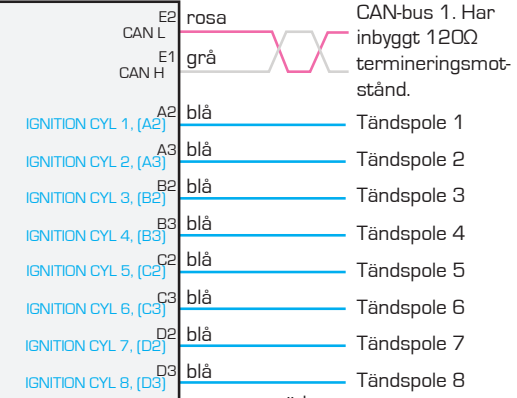

Alla GPO/INJ har 30V flyback inbyggt som standard.



MaxxECU V1



MaxxECU RACE



MaxxECU PRO

Alternativ för anslutning av tändspolar

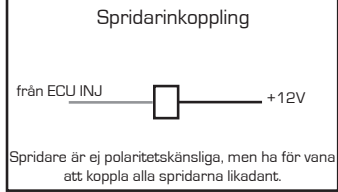
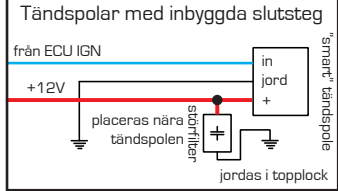
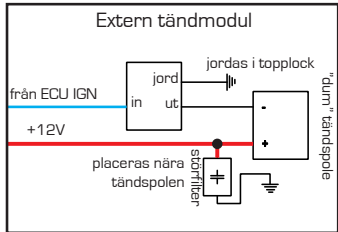

Inkoppling extra utgångar

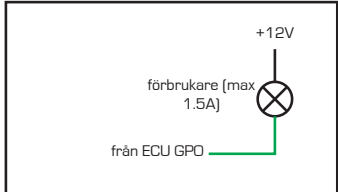

Inkoppling relä

